

ARCHÈ - ARROW

OSCARTIELLE

Archè

	Lunghezza totale Total length	Lunghezza interno vasca Basin internal length	Superficie d'esposizione orizzontale (1) Horizontal display surface (1)	Classe di temperatura Temperature class	Temperatura di conservazione Storage temperature °C	Etichetta energetica (2) Energy label (2)
	mm	mm	m ²			
130	1270	1250	1,13	3M2	+2/+4	
190⁽³⁾	1895	1875	1,69			
C Max 130	1270	1250	1,13	3M2	+2/+4	
C Max 190⁽³⁾	1895	1875	1,69			
C Max XP 100	977	937	0,84	3M1	0/+2	
C Max XP 130	1290	1250	1,13			
C Max XP 190⁽³⁾	1915	1875	1,69			
XP 100	977	937	0,74	3M1	0/+2	

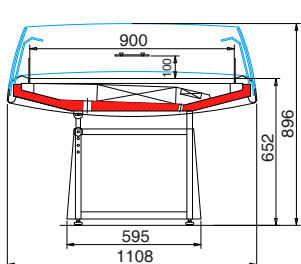

Archè

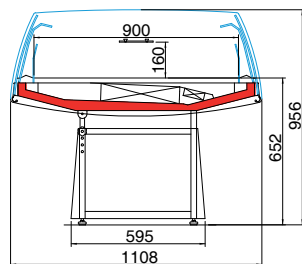

Archè C Max

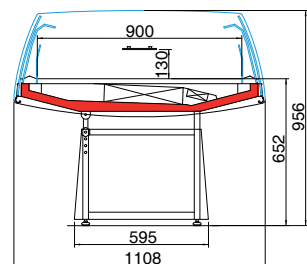

Archè C Max XP

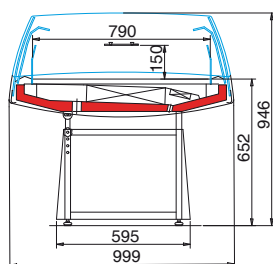

Archè XP



Arrow

	Lunghezza totale Total length	Lunghezza interno vasca Basin internal length	Superficie d'esposizione orizzontale (1) Horizontal display surface (1)	Classe di temperatura Temperature class	Temperatura di conservazione Storage temperature °C	Etichetta energetica (2) Energy label (2)
	mm	mm	m ²			
C Max 130	1290	1250	1,13	3M1	0/+2	
C Max 190⁽³⁾	1915	1875	1,69			
100	977	937	0,74	3M1	0/+2	

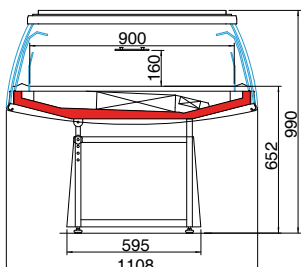

Arrow C Max

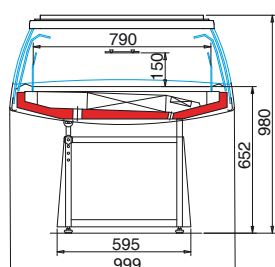

Arrow



Archè VD

	Lunghezza totale	Lunghezza interno vasca	Superficie d'esposizione orizzontale (1)	Classe di temperatura	Temperatura di conservazione	Etichetta energetica (2)
	Total length	Basin internal length	Horizontal display surface (1)	Temperature class	Storage temperature °C	
	mm	mm	m ²			
P90 C10 MP 100	977	937	0,84			
P90 C10 MP 130	1290	1250	1,13	3M2	+2/+4	
P90 C10 MP 190⁽³⁾	1915	1875	1,69			
P90 C18 MP 100	977	937	0,84			
P90 C18 MP 130	1290	1250	1,13	3M2	+2/+4	
P90 C18 MP 190⁽³⁾	1915	1875	1,69			
P90 C15 XP 100	977	937	0,84			
P90 C15 XP 130	1290	1250	1,13	3M1	0/+2	
P90 C15 XP 190⁽³⁾	1915	1875	1,69			
P79 C18 XP 100	977	937	0,74			
P79 C18 XP 130	1290	1250	0,99	3M1	0/+2	
P79 C18 XP 190⁽³⁾	1915	1875	1,48			
P61 C18 XP 120	1200	1160	0,71	3M1	0/+2	
H120 XP 100	967	937	1,29	3M1	0/+2	
H120 XP 130	1280	1250	1,72			
Twin H136 MP 130	1290	1250	2,70	3M2	+2/+4	
Twin H136 XP 130	1290	1250	2,70	3M1	0/+2	

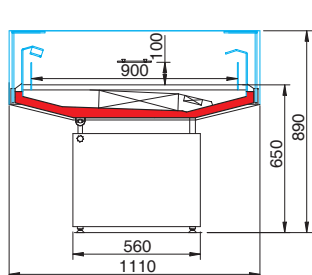

Archè VD P90 C10 MP

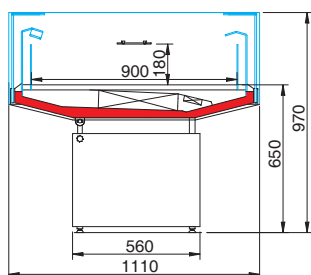

Archè VD P90 C18 MP

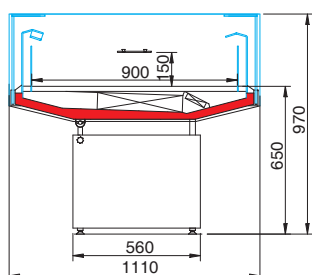

Archè VD P90 C15 XP

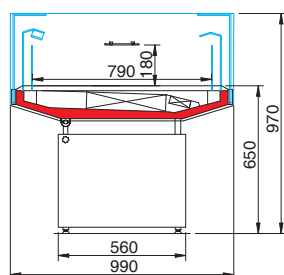

Archè VD P79 C18 XP

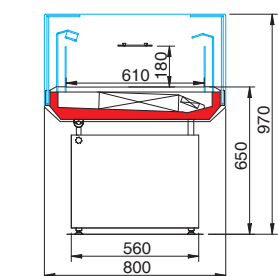

Archè VD P61 C18 XP

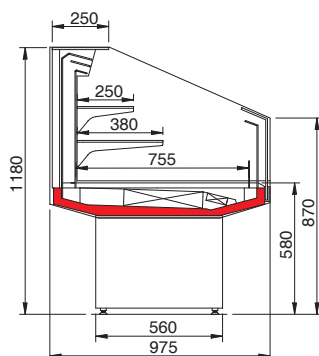

Archè VD H120

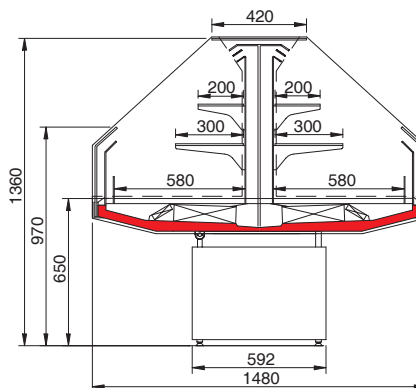

Archè VD Twin H136

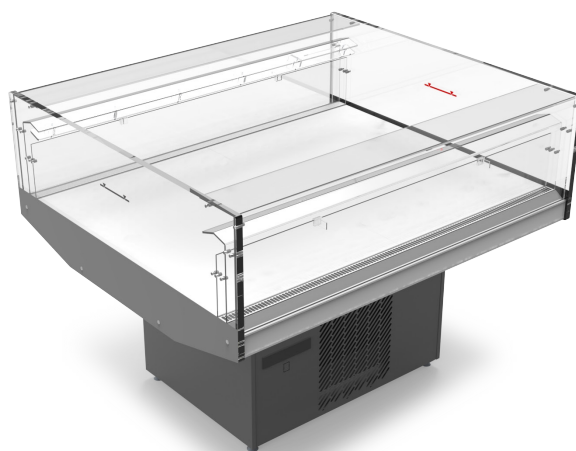

Arrow VD

	Lunghezza totale Total length	Lunghezza interno vasca Basin internal length	Superficie d'esposizione orizzontale (1) Horizontal display surface (1)	Classe di temperatura Temperature class	Temperatura di conservazione Storage temperature °C	Etichetta energetica (2) Energy label (2)
	mm	mm	m ²			
P90 C18 XP 100	977	937	0,84			
P90 C18 XP 130	1290	1250	1,13	3M1	0/+2	
P90 C18 XP 190⁽³⁾	1915	1875	1,69			
P79 C18 XP 100	977	937	0,74			
P79 C18 XP 130	1290	1250	0,99	3M1	0/+2	
P79 C18 XP 190⁽³⁾	1915	1875	1,48			
P61 C18 XP 120	1200	1160	0,71	3M1	0/+2	

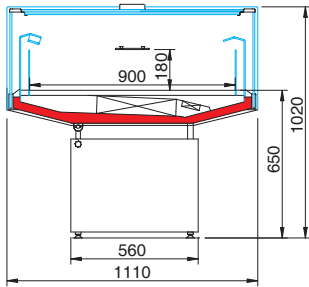

Arrow VD P90 C18 XP

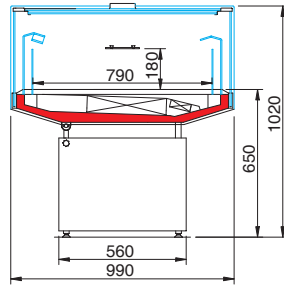

Arrow VD P79 C18 XP

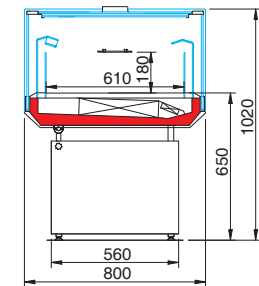

Arrow VD P61 C18 XP

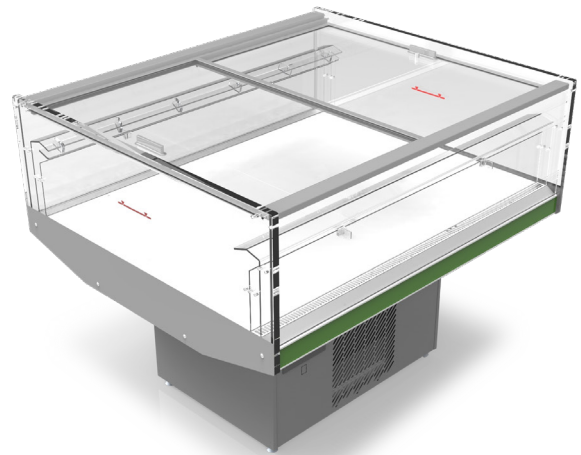

(1) Valore riferito alle configurazioni illustrate. Value referred to illustrated configurations.

(2) L'etichetta energetica può variare in base alla configurazione del prodotto. The energy label may vary depending on product configuration.

(3) Non disponibile con R290 - Not available with R290.

Contenuto modificabile senza preavviso. - Content can be changed without notice.



Disponibile - Available



OSCARTIELLE

YOUR GLOBAL PARTNER FOR RETAIL SOLUTIONS

www.oscartielle.it